

Project Name		Customer Name	
Quote Number		Date	
Customization			

### Standard Features

<b>Type</b>	One-piece transfer type shower stall with return flange. Available in right or left hand configuration.
<b>Color</b>	White
<b>Exterior Dimensions</b>	38"W x 38"D x 78-1/2"H
<b>Materials</b>	Gel coat and fiberglass composite
<b>Approximate Weight</b>	130 lbs

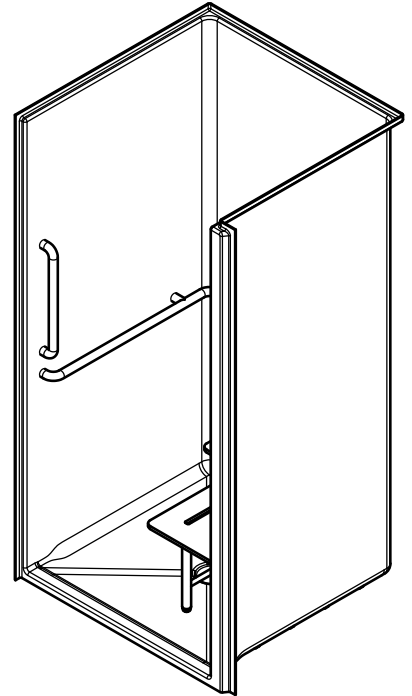

### Certifications and Accessibility Code Compliance



Universal Plumbing Code



CSA B45.5-11 / IAPMO Z124-2017



ADA

**ANSI**

ICC A117.1 - 2017 ANSI Type A



HUD / FHA

### Warranty

30 Year Limited

### Reinforcement

Fully reinforced with EverFab's unique composite core material which allows for factory or field installation of ADA compliant grab bars and seat

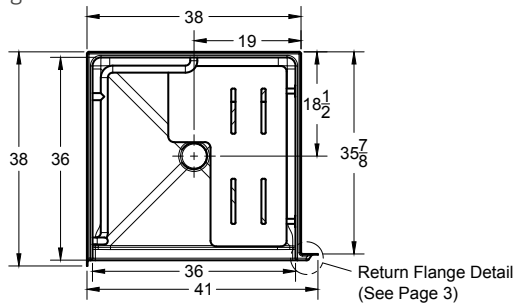

Return Flange Detail (See Page 3)

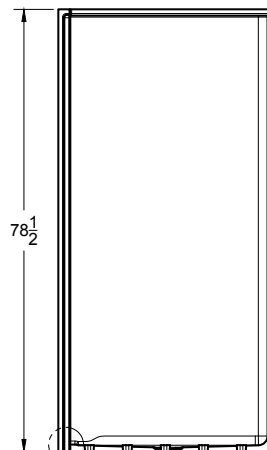
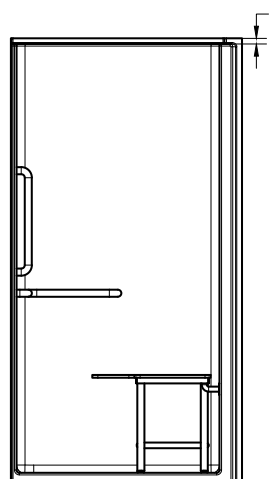

Threshold Detail (See Page 3)

Reinforcing Bottom Plate

Due to the nature of the material, all measurements may vary by  $\pm 3/8"$ .  
Dimensions needed for site preparation should be measured from the unit.

## ADA Accessory Dimensions

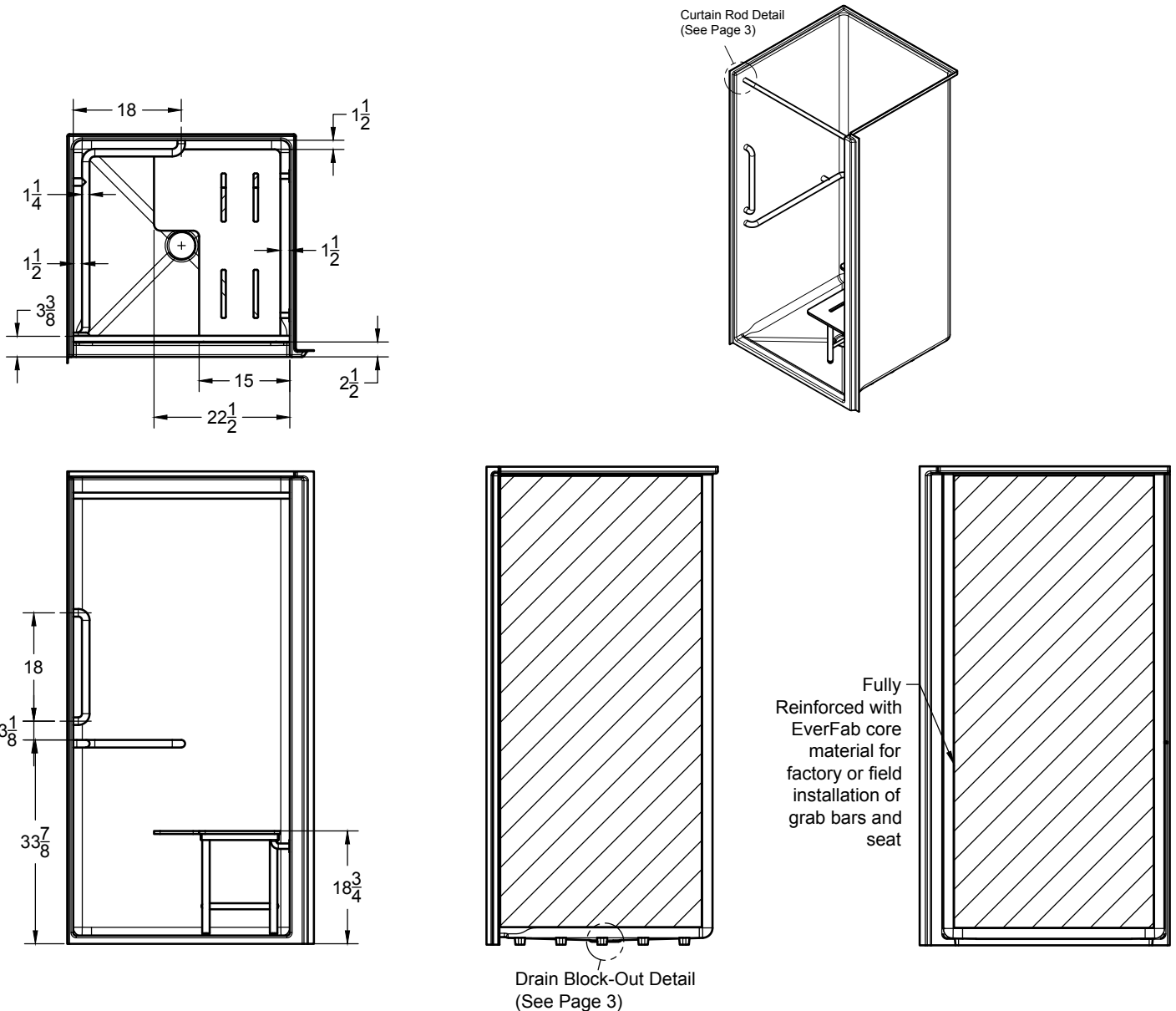

## Architectural Specifications

### A. Shower Stall:

1. Model: No. S3838RFA-L/R
2. Description: One-piece shower stall with reinforcing bottom plate, slip-resistant floor, return flange, and inorganic composite reinforcement for placement of grab bars and seat
3. Exterior dimensions: 38 inches wide x 41 inches deep x 78-1/2 inches high
4. Rough-in: +1/8" -0" nominal dimensions
5. Threshold: [Standard] [Low Profile] Threshold Detail
6. Accessibility Accessories: [A0] [A1] [Custom] accessory configuration
7. Optional Accessories: Furnish with [curtain rod], [shower curtain], [recessed soap dish], [composite corner shelf], [shower slide-bar kit], [EverFab tub-wrap], [shower drain], [18" grab bar], [24" grab bar], [custom grab bar], [folding seat], [T-shaped EverDam]. If applicable, please indicate location of additional accessories on drawing
8. Accessory Style: [A0 - No Accessories], [Standard Thru-Bolted], [Flanged], [Elite Series], [Anti-Ligature], [Custom]
9. Accessory Finish: [A0 - No Accessories], [Standard Satin Stainless], [Matte Black], [Polished Stainless] [White], [Custom]

**ADA Accessory Configurations (number following 'A' indicates configuration)**

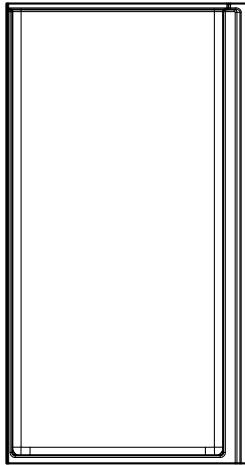

**S3838RFA0-R**

No Accessories

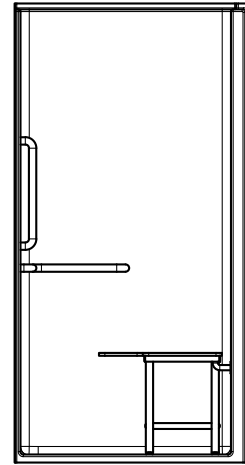

**S3838RFA1-R**

L-shaped grab bar

Seat

18" vertical grab bar

**Threshold Details**

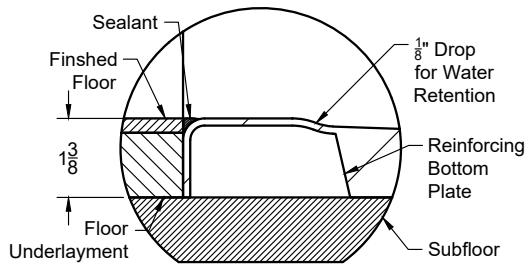

**Standard**

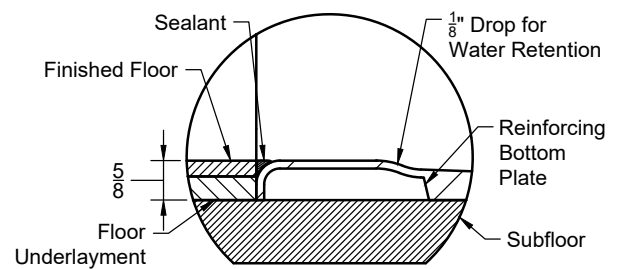

**Low-Profile**

Model number followed with 'LP'

**Additional Details**

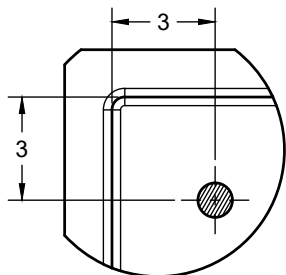

**Standard Curtain Rod Location**

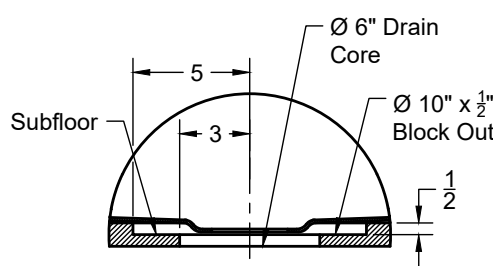

**Drain Block-Out**

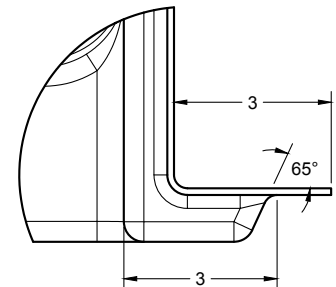

**Return Flange**

### Standard Threshold Models

Model Number	Pre-Installed L-Shaped Grab Bar	Pre-Installed 18" Vertical Grab Bar	Pre-Installed Folding Seat	Drain Block Out Required	Accessibility Code Compliance
<input type="checkbox"/> S3838RFA0	No	No	No	No	Adaptable**
<input type="checkbox"/> S3838RFA1	Yes	Yes	Yes	No	ADA, ANSI, HUD/FHA

### Low Profile Threshold Models

Model Number	Pre-Installed L-Shaped Grab Bar	Pre-Installed 18" Vertical Grab Bar	Pre-Installed Folding Seat	Drain Block Out Required	Accessibility Code Compliance
<input type="checkbox"/> S3838RFA0LP	No	No	No	Yes	Adaptable**
<input type="checkbox"/> S3838RFA1LP	Yes	Yes	Yes	Yes	ADA, ANSI, HUD/FHA

*\*\*Model is reinforced and capable of meeting accessibility code requirements with proper field-installation of grab bars and seat*

### Flange and Seat (if applicable) Placement (indicated by '-L' or '-R' following model number)\*

- Left Hand  Right Hand

*\*Flange and seat placement is determined as if outside the unit looking in. For clarity, a right hand model is shown in all drawings.*

### Optional Accessories†

- |   |   |
|---|---|
| <input type="checkbox"/> Curtain Rod            | <input type="checkbox"/> Shower Drain                     |
| <input type="checkbox"/> Shower Curtain         | <input type="checkbox"/> Custom grab bar, please specify: |
| <input type="checkbox"/> Recessed Soap Dish     | <input type="checkbox"/> Folding seat                     |
| <input type="checkbox"/> Composite Corner Shelf | <input type="checkbox"/> T-Shaped EverDam                 |
| <input type="checkbox"/> Shower Slide-Bar Kit   |   |
| <input type="checkbox"/> EverFab Tub-Wrap       |   |

### Accessory Style

- Thu-bolted (Standard)  
 Flanged  
 Elite Series  
 Anti-ligature  
 Custom, please specify:

### Accessory Finish

- Satin Stainless (Standard)  
 Matte Black  
 Polished Stainless  
 White  
 Custom, please specify:

*†If applicable, please select accessory style and finish from options above. If custom, please also indicate desired location(s) on drawing.*